

CX14 (II ED.) BASIC 1150X685

SMALL SIZE, GREAT MANOEUVRABILITY



ELECTRIC PALLET TRUCK - CX14

The new CX14 electric pallet trucks are compact, lightweight and easy to use. They have been specifically designed for use in confined spaces within rail, shops, supermarkets and on-board delivery vehicles. These simple and efficient pallet trucks are built to last and are perfect for all your pedestrian material handling needs.



BASIC VERSION

The BASIC version is equipped with:

- Starting type battery
- Tiller made with metal tube and ergonomic fingertip controls
- Reliable DC drive system

A configuration that offers best value for money.



MANOEUVRABILITY

- Short chassis dimension (L2 = 410 mm) to offer improved manoeuvrability in confined spaces.
- Compact design perfect for working in narrow areas and corridors, featuring a tighter turning radius (Wa = 1345 mm) for faster pinwheeling and easier navigation in congested spaces.
- Smooth rounded fork tips and entry/exit rollers to optimize pallet handling.



RELIABILITY

- Robust frame (metal motor wheel protection 6 mm thick) designed to guarantee maximum durability and resistance to torsion and heavy loads.
- Battery discharge indicator to allow easy management.
- Easy access to electrical components for maintenance.

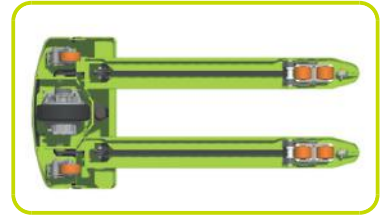

PRODUCTIVITY

- Strong ABS cover with storage tray on top, easily removable for simple access to batteries and key components speeding-up maintenance operations.
- Easy access to the motorwheel components through dedicated inspection opening.
- Schuko plug with spiral cable and on board battery charger.



INTELLIGENT TILLER

- Ergonomic tiller designed for both left and right handed operation.
- Butterfly valves for traction control.
- Safety push button with warning buzzer.
- Turtle function for moving in tight areas with the handle in vertical position while remaining almost within the profile of the machine.



TURTLE MODE SWITCH

Offered as standard, this function enables operating the truck in confined spaces: it allows the unit to travel with the tiller in upright position.

This function is activated by pressing the turtle button on the tiller and rotating the drive control throttle. The truck travels at limited speed.

Release the button to disable this function.



ON-BOARD BATTERY CHARGER

Built-in battery charger provides a convenient charging solution and eliminates the need to remove the battery from the machine.



TRACTION & SAFETY

Traction is granted by the biggest heavy-duty stabilizer wheels (100x40 mm) in the category, with heavy duty spring. All linkage connection done through bushings that increase stability and durability.



ROLLERS

Standard configuration provided with single polyurethane rollers. Available tandem rollers as optional.



Descriere

1.1 Producător			PR INDUSTRIAL
Stivuitoar			ELECTRICĂ
1.3 Comandă			ELECTRICĂ
1.4 Poziție operare			Pedestru
1.5 Capacitate maximă	Q	Kg	1400
1.6 Distanța la centrul de aplicare al sarcinii	c	mm	600
1.8 Sarcina de la osie la capătul furcilor	x	mm	935
1.9 Ampatament	y	mm	1196

Greutăți

2.1 Greutate de operare (acumulator inclus)		Kg	223
2.2 Sarcină osie, încărcare pe spate		Kg	1042
2.2 Sarcină osie, încărcare pe față		Kg	581
2.3 Sarcină osie, liber față		Kg	186
2.3 Sarcină osie, liber spate		Kg	38

Cauciucuri/Șasiuri

3.1 Cauciucuri: roți direcție			CAUCIUC
3.1 Cauciucuri: roți stabilizatoare - Față			POLY.C.
3.1 Cauciucuri: transportoare cu role			POLY.C.
3.2 Mărime cauciuc: roți direcție - Lățime		mm	76
3.2 Mărime cauciuc: roți direcție - Diametru		mm	250
3.3 Mărime cauciuc: transportoare cu role - Diametru		mm	82
3.3 Mărime cauciuc: transportoare cu role - Lățime		mm	80
3.4 Mărime cauciuc: roți stabilizatoare față - Diametru		mm	100
3.4 Mărime cauciuc: roți stabilizatoare față - Lățime		mm	40
3.5 Dimensiune cauciuc: roți spate		nr	2
3.5 Dimensiune cauciuc: roți fata		nr	1x
3.6 Ecartament, față	b10	mm	530
3.7 Ecartament, spate	b11	mm	535

Dimensiuni

4.4 Înălțime stivuitoar	h3	mm	115
4.9 Height of tiller in drive position min	h14	mm	730
4.9 Înălțime manetă în poziția de deplasare, max	h14	mm	1230
4.15 Înălțime, coborât	h13	mm	85
4.19 Lungime globală	l1	mm	1560
4.20 Distanța până la suprafața frontală a furcilor	l2	mm	410
4.21 Lățime globală	b1	mm	720
4.22 Dimensiuni furcă - grosime	s	mm	55
4.22 Dimensiuni furcă - Lățime	e	mm	150
4.22 Dimensiuni furcă - Lungime	l	mm	1150
4.25 Distanța între furci	b5	mm	685
4.32 Gardă la sol și mijloc ampatament	m2	mm	30
4.34 Lățime culoar	Ast	mm	1810
4.35 Rază de virare	Wa	mm	1345

Performante

5.1 Viteză de deplasare cu incarcare	Km/h	4.4
5.1 Viteză de deplasare fără incarcare	Km/h	4.8
5.10 Frână de serviciu		REVERSE CURRENT BRAKING

Motoare electrice

6.6 Consum de energie în ciclu VDI	kWh/h	0.25
8.4 Nivel sonor la nivelul urechii șoferului	dB(A)	59

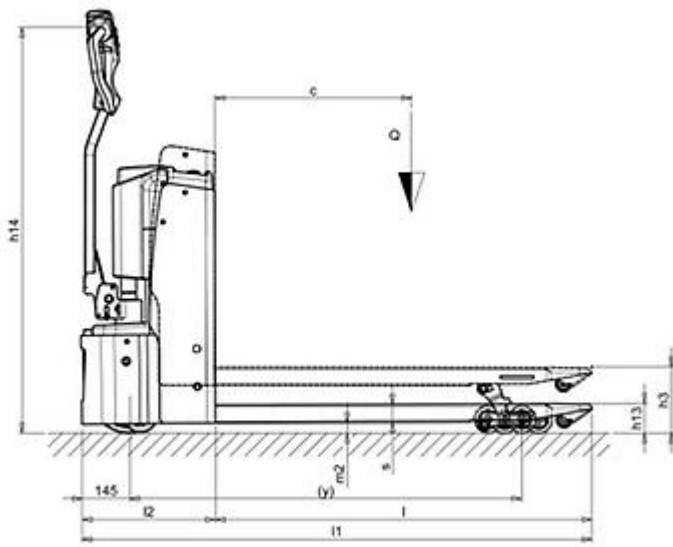
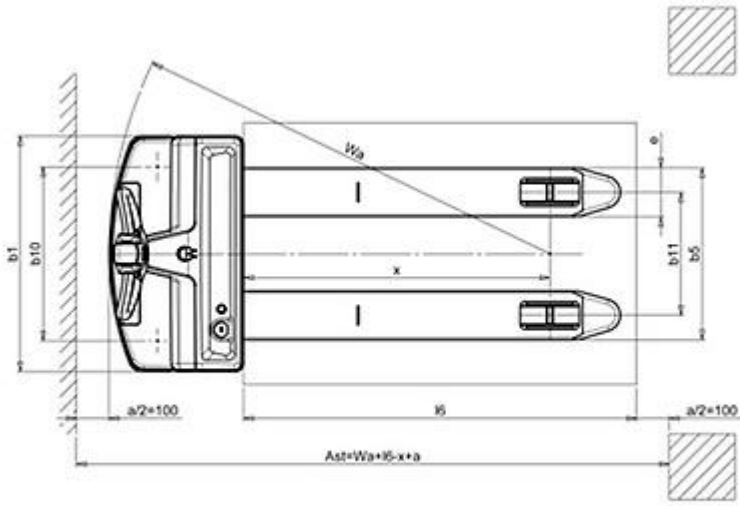

The information is aligned with the Data file at the time of download. Printed on 24/02/2020 (ID 9001)

©2019 | PR INDUSTRIAL s.r.l. | All rights reserved | Image shown may not reflect actual package. Specifications subject to change without notice

